

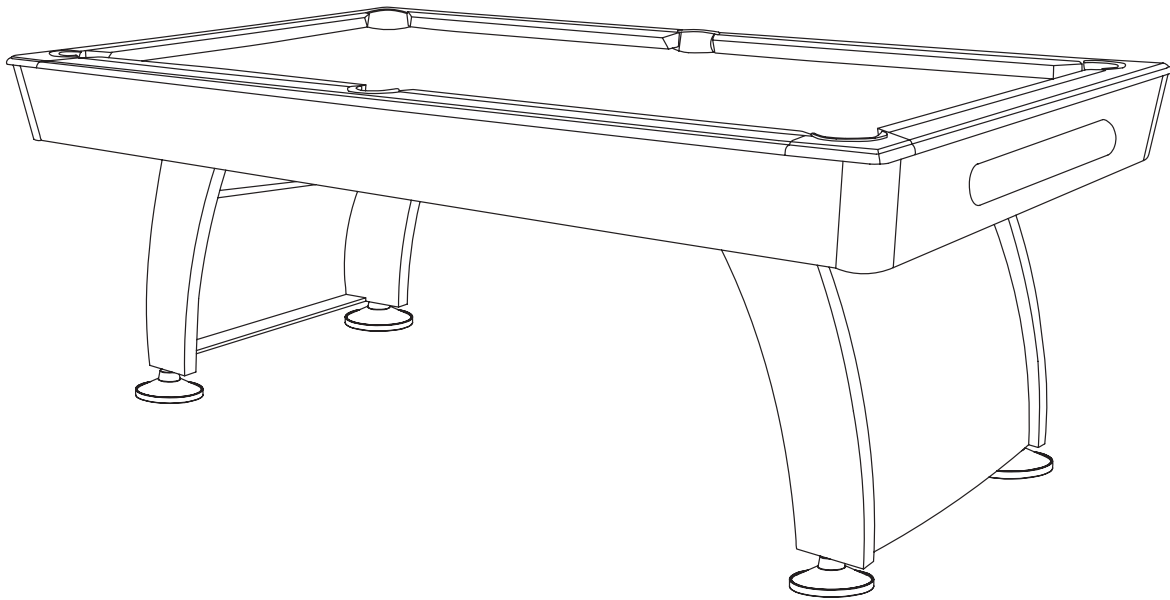

Tuscon MMXI Billiard Table

Item 64-0146

TUSCON MMXI BILLIARD TABLE



Replacement Parts

Order direct at www.gldproducts.com
or call our Customer Service department at
(800) 225-7593 ext. 113
8 am to 4:30 pm Central Standard Time

Staple your receipt here.

Important: A copy of your receipt will be needed to activate your warranty (see page page 12)





Congratulations and THANK YOU for purchasing the Tuscon MMXI Billiard Table. You have chosen a product that should provide years of entertainment. To assist you with customer service and warranty claims, staple your receipt to the inside cover, then keep this manual in a safe place for future reference.

















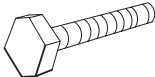

GLD Products

S84 W19093 Enterprise Drive
Muskego, WI 53150 USA
1-800-225-7593 ext. 113
Fax: 1-800-841-6944
Email: gld@gldmfg.com
Web: www.gldproducts.com

This manual may have been updated. For the latest manual visit the GLD products website.

	<p>Place your package near the location where it will be used. Carefully unpack all components and verify you have all the correct pieces.</p> <p>If you notice missing or defective parts, please call us at: 1-800-225-7593 ext. 113</p>
---	---

	<p>Please read and understand all instructions before beginning assembly.</p> <p>This assembly will require 2 adults.</p> <p>This product is not for use by children without adult supervision.</p>
---	--

Part No./ Qty	Illustration/ Order Number	Part No./ Qty	Illustration/ Order Number	Part No./ Qty	Illustration/ Order Number
1 Qty. 2	 Left Leg Order No. 1-213	2 Qty. 2	 Right Leg Order No. 1-214	3 Qty. 4	 Leg Support Order No. 1-215
4 Qty. 1	 Table Top Assembly Order No. 1-224	5 Qty. 2	 Leg End Panel Order No. 1-217	6 Qty. 16	 1/4" x 2" Bolt Order No. 2-180
7 Qty. 16	 1/4" Washer 19 mm Order No. 1-220	8 Qty. 16	 1/4" Barrel Nut Order No. 2-12	9 Qty. 12	 5/16" x 2" Bolt Order No. 1-11
10 Qty. 12	 5/16" Washer 19 mm Order No. 1-90	11 Qty. 4	 Leg Leveler Order No. 1-219	12 Qty. 1	 Billiard Balls Order No. 2-21
13 Qty. 1	 Triangle Order No. 2-27	14 Qty. 2	 Cue Order No. 2-23	15 Qty. 2	 Chalk Order No. 2-24
16 Qty. 1	 Brush Order No. 1-221	17 Qty. 1	 Wrench Order No. 1-17	18 Qty. 1	 Allen Wrench Order No. 2-116
19 Qty. 1	 Table Top Assembly Order No. 1-224				

IF YOU HAVE A WARRANTY CLAIM, CALL US FIRST

Please see page 12.

GLD Products

Available 8 am to 4:30 pm Central Standard Time

S84 W19093 Enterprise Drive
Muskego, WI 53150 USA
1-800-225-7593 ext. 113
Fax: 1-800-841-6944
Email: gld@gldmfg.com
Web: www.gldproducts.com

For all claims, please have your receipt and item number when you call. The product item number can be found on the front cover.

If you are instructed to return the product for service, you are responsible for shipping the unit at your expense.

PRODUCT REGISTRATION

Important: The product registration form on page 15 and a copy of your receipt must be completed and returned within 10 days of purchase to validate your warranty.

Preparing for Assembly

- Be sure to unpack all of the parts included in this package. Some parts may be in obscure locations of the packaging. Check inside any tubes or sleeves. Save all packing material until the product is fully assembled and functional.
- Compare the parts in your package with the Parts Identifier description on page 5.

Tools Required

- Wrench (#17)
- Allen Wrench (#18)
- Level (not included)
- Electric screwdriver may be helpful. **CAUTION:** You must set at **LOW TORQUE** and use extreme caution because you could overtighten the hardware, strip the screws, or damage the table.

Assembly Tips

Make sure you understand the following before you begin to assemble your pool table.

1. READ THIS MANUAL all the way through before beginning assembly.
2. When installing parts that have more than one bolt, start ALL bolts in that part by hand before tightening anything.
3. Some drawings or images in this manual may not look exactly like your product.
4. You will need a second adult to assist with this assembly.

Note: Save all packing materials until the parts have been inspected and the table is assembled.

Unpack the Pieces

- Lay the box top side down on a flat surface (floor). You may want this near your area of assembly.
- Unpack the boxes and part bags. Inspect and count the parts. The Parts Identifier page can be used to record your results.
- If any parts are damaged or missing contact GLD customer service.
- Missing fasteners may be purchased at a hardware store using the descriptions on the Parts Identifier page(s).

STEP 1 - ASSEMBLE THE LEGS

1. Lay the leg supports (#3) on the floor with the side that has the four holes facing up. Put a barrel nut (#8) in each hole with the threaded hole facing the short edge.
2. Hold one of the legs (#1 or #2) on edge. Hold the leg support (#3) against the leg, lining up the bolt holes. The holes for the barrel nuts (#8) should face toward the bottom of the leg.
3. Place a washer (#7) over a bolt (#6) and insert the bolt through the leg into the barrel nut in the leg supports. Finger start the bolt. Repeat for the second bolt and finger tighten both bolts.
4. Hold the second leg in position. Insert the two bolts (#6) with washers (#7) through the leg and finger tighten.
5. Repeat Steps 3 & 4 for the bottom leg support (#3).

6. The leg end panel (#5) should slide into the channels on the legs. It may be helpful to stand the leg assembly up as shown. This will help prevent the leg assembly from becoming angled and preventing the leg end panel from sliding into place. The side of the leg end panel that is visually better should be to the outside of the curve.
7. When the leg end panel (#5) is in place tighten all eight support bolts (#6) using the allen wrench (#18).
8. Repeat for the second leg assembly

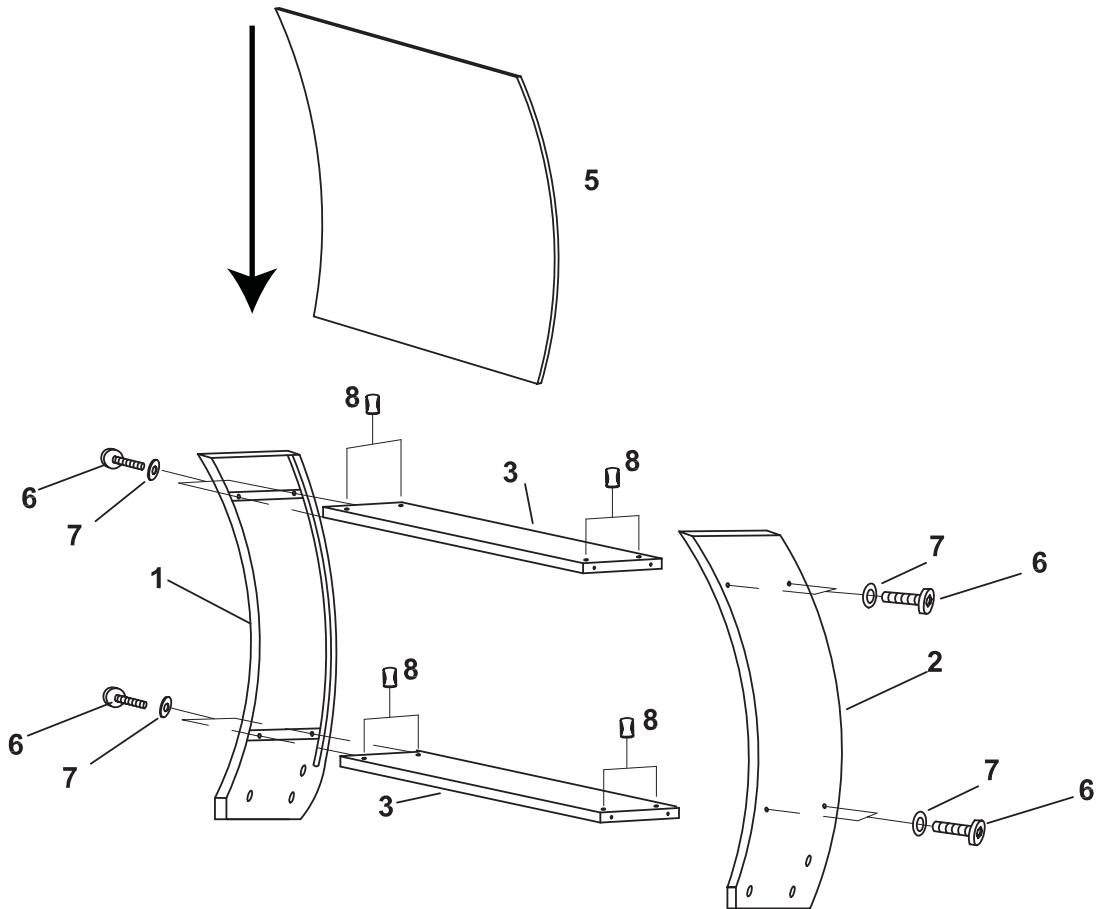

STEP 2 - CONNECT LEG ASSEMBLIES

1. Place the table top upside down on a flat surface.
2. Position one leg assembly from Step 1 inside the framework of the table top.
3. Place a washer (#10) over a bolt (#9). Insert the bolt through the leg assembly and into the threaded hole in the frame. Finger tighten.
4. Repeat for the other five bolts.
5. Tighten all six bolts using the wrench (#17)
6. Repeat for the second leg assembly.
7. Screw a leg leveler (#11) halfway into the hole in each leg.

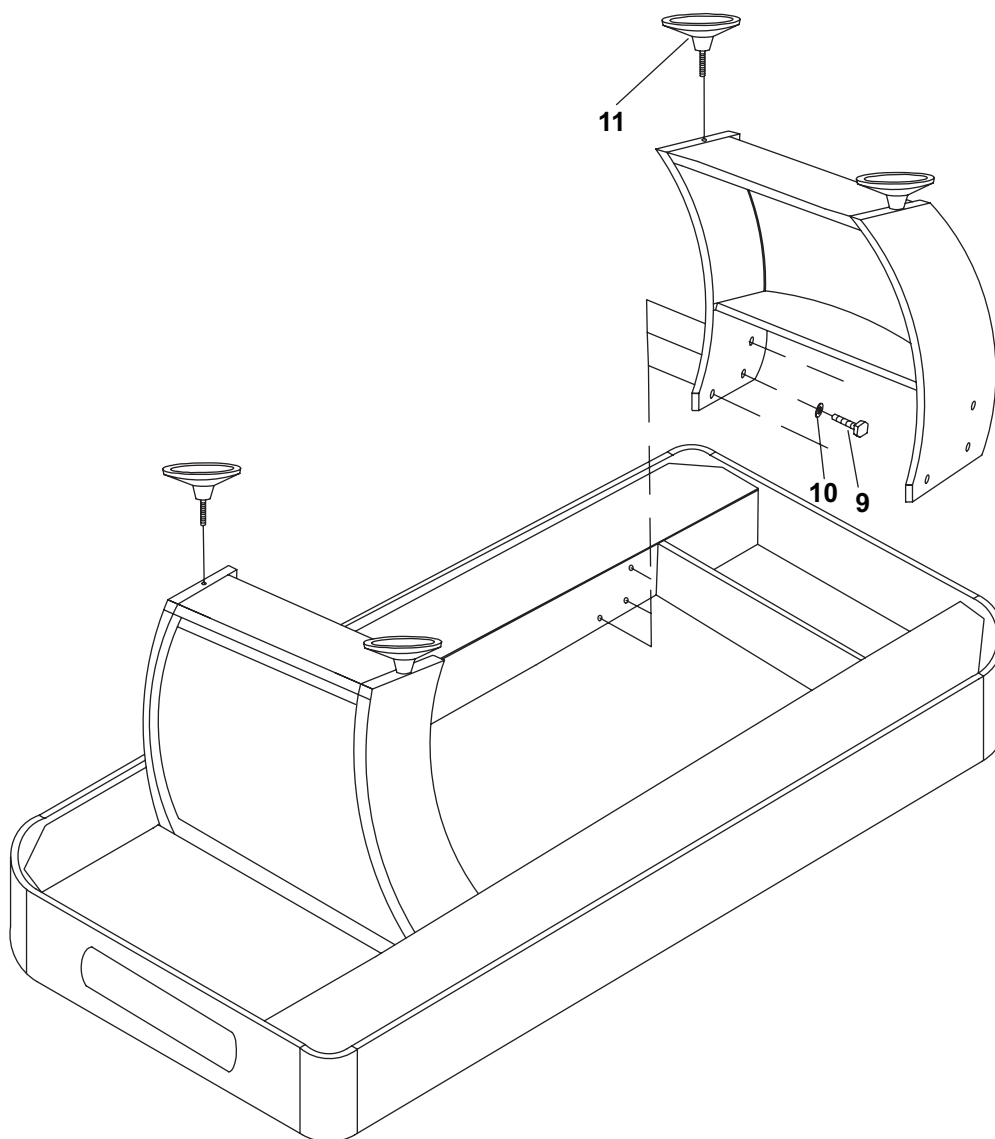

Care and Use of your Table

- This product is intended for INDOOR use only.
- DO NOT sit, climb, or lean on the table.
- DO NOT drag the table when moving it. This will damage the legs.
- Keep your table covered. The playing surface can be brushed to keep clean.
- DO NOT lift the table by placing your hands under the pockets, and do not sit, lean or put pressure on the pockets.
- The cloth playing surface can rip or tear. Keep sharp objects off the playing surface.
- Some “trick shots” may tear or dimple the cloth surface.
- To clean the hard surfaces spray a cloth with a mild cleaner and wipe.

90-DAY LIMITED WARRANTY

The Manufacturer warrants to the original retail purchaser that this product is free from defects in material and workmanship under normal use and conditions for a period of ninety (90) days from the date of original purchase. The Manufacturer's liability is limited to the repair or replacement, at its option, of any defective product and shall not include any liability for indirect, incidental or consequential damages of any kind.

Should this product become defective due to material or workmanship within the warranty period, contact our Customer Service Department. This warranty is not transferable and does not cover normal wear and tear or damage caused by improper usage, negligence, misuse, abuse, transportation damage, acts of nature, or accident (including failure to follow the instructions in this manual). It does not cover expendable items such as batteries, light bulbs, fuses, accessories, cosmetic parts and other items that wear out due to normal usage, including felt covered areas of the playing surface. This warranty is also void if the product is disassembled and reassembled, damaged, modified from its original state, or used for other than indoor personal residential use (no commercial or rental applications).

This warranty gives you specific legal rights, and you may have other rights which vary from state to state.

IF YOU HAVE A WARRANTY CLAIM, CALL US FIRST (8 - 4:30 CST)

Please have your receipt and item number (found on the front cover) when you call.

GLD Products

S84 W19093 Enterprise Drive
Muskego, WI 53150 USA
1-800-225-7593 ext. 113
Fax: 1-800-841-6944
Email: gld@gldmfg.com
Web: www.gldproducts.com

If you are instructed to return the product for service, you are responsible for shipping the unit at your expense to the above address in packaging that will protect against further damage. All warranty or repair requests require a Return Authorization Number prior to returning the item.

PRODUCT REGISTRATION

Important: The product registration form on page 13 must be completed and returned along with a copy of your receipt within 10 days of purchase to validate your warranty.

REGISTER YOUR PRODUCT

Place postage here

Complete this form, include a copy of your receipt, fold, tape (do not staple) and return within 10 days of purchase. This protects your warranty and will help us develop new products!

Cut here.

GLD Products
Warranty Department
S84 W19093 Enterprise Drive
Muskego, WI 53150 USA

Fold here second.



P R O D U C T S

www.gldproducts.com

GAME TABLES	HOME CASINO
GAMES AND ACCESSORIES	BILLIARD CUES
BILLIARD ACCESSORIES	DARTBOARDS
SOFT-TIP DARTS	STEEL-TIP DARTS
FLIGHTS AND SHAFTS	DART CASES AND ACCESSORIES

Fold here first.

Name	Date of Purchase
Address	Phone-Day
City	Phone-Evening
State Zip	Email
Purchase Price:	Item: 64-0146 Tuscon MMXI Billiard Table
Store Name:	

1. What are the top two reasons that influenced the purchase of this product? Select two.

<input type="checkbox"/>	Brand reputation	<input type="checkbox"/>	Prior experience with another GLD product
<input type="checkbox"/>	Saw in an advertisement	<input type="checkbox"/>	Color/appearance
<input type="checkbox"/>	Quality/durability	<input type="checkbox"/>	Other
<input type="checkbox"/>	Value for price		

2. How did you become aware of this product? Select two.

<input type="checkbox"/>	Saw in an advertisement	<input type="checkbox"/>	Saw it in the store
<input type="checkbox"/>	Saw or used a friend's or relative's	<input type="checkbox"/>	Recommended by another person
<input type="checkbox"/>	Received as a gift	<input type="checkbox"/>	Other

3. Rate your satisfaction with each of the following?

	Excellent	Good	Fair	Poor
Assembly instructions				
Ease of assembly				
Packaging				
Overall product satisfaction				

4. Were there any parts missing?

Yes No If so, which ones? Order No. _____

5. Based on your experience, would you buy another GLD product?

Yes No

6. Is this the first GLD product that you've owned? If No, what other product have you owned?:

Yes No _____

7. Have you owned products from:

Sportcraft Harvard Classic Sport Other

8. When did you decide to purchase this product?

Before entering the store. While in the store/impulse purchase

9. How many times per month will you use it?

1 to 3 4 to 8 9 to 15 16 +

10. Are you the intended user of this product?

Yes No, indicate who: _____

11. Where will you use this product?

Home Other: _____

12. Please tell us your gender?

Male Female

13. And your marital status?

Married Single

14. Age?

Under 25 25 - 40 40 - 60 Over 60

15. Which best describes your family income?

<input type="checkbox"/>	Under \$25,000	<input type="checkbox"/>	\$25,000 - \$49,999	<input type="checkbox"/>	\$50,000 - \$99,999
<input type="checkbox"/>	\$100,000 - 149,999	<input type="checkbox"/>	\$150,000 - \$199,999	<input type="checkbox"/>	Over \$200,000

16. Education:

<input type="checkbox"/>	Some high school	<input type="checkbox"/>	College degree
<input type="checkbox"/>	Completed high school	<input type="checkbox"/>	Graduate degree

Remember to attach a copy of your receipt.

Mail To: GLD Products
 S84 W19093 Enterprise Drive
 Muskego, WI 53150 USA
 1-800-225-7593 • FAX 800-841-6944
 Email: gld@gldmfg.com
 Web Site: www.gldproducts.com

Tuscon MMXI Billiard Table

Item 64-0146

Parts Re-Order Form

Name		Date
Address		Phone-Day
City		Phone-Evening
State	Zip	Email

Order No.	Description	Unit Price	Qty.	Total Amount
1-213	Left Leg	15.00		
1-214	Right Leg	15.00		
1-215	Leg Support	10.00		
1-217	Leg End Panel	15.00		
2-180	1/4" x 2" Bolt	0.75		
1-220	1/4" Washer 19 mm	0.20		
2-12	1/4" Barrel Nut	0.25		
1-11	5/16" x 2" Bolt	1.00		
1-90	5/16" Washer 19 mm	0.20		
1-219	Leg Leveler	10.00		
2-21	Billiard Balls	30.00		
2-27	Triangle	6.00		
2-23	Cue	12.00		
2-24	Chalk	2.00		
1-221	Brush	5.00		
1-17	Wrench	1.00		
2-116	Allen Wrench	1.00		
1-224	Table Top Assembly	150.00		
		Subtotal		
Shipping will be added. If paid by Check or Money Order, call for quote.		S/H		
5.1% Waukesha Wisconsin tax will apply (subject to change).		Tax		
		Total		

Method of Payment

Check or Money Order
 Credit Card
 Visa MasterCard Discover American Express
 Card # _____
 Security Code # _____ Billing Address Zipcode _____
 Signature _____ Exp. Date _____

Shipping Address

Name _____
 Address _____ Phone _____
 City _____ State _____ Zip _____



www.gldproducts.com

GAME TABLES

HOME CASINO

GAMES AND ACCESSORIES

BILLIARD CUES

BILLIARD ACCESSORIES

DARTBOARDS

SOFT-TIP DARTS

STEEL-TIP DARTS

FLIGHTS AND SHAFTS

DART CASES AND ACCESSORIES



PROUD MANUFACTURER OF



S84 W19093 Enterprise Drive • Muskego, WI 53150 USA
262.679.8730 or 1.800.225.7593 tele
262.679.8738 or 1.800.841.6944 fax
262.679.8739 international fax
Email: gld@gldmfg.com
www.gldproducts.com